

Partnr. 34B-F84A8-XX



## USER GUIDE















39L Top case



50L Top case



Posnr.	QTY	
①	1	 39L
②	1	 5B2-F413B-00
③	1	 16P-F8338-00
④	2	 M3 x 8 mm
⑤	1	
⑥	1	 <b>NOT INCLUDED</b> 52S-21780-09
⑦	1	<b>NOT INCLUDED</b> * OPTION 59C-281C0-00

Posnr.	QTY	
①	1	 50L
②	1	 5B2-F413B-00
③	1	 16P-F8338-00
④	2	 M3 x 8 mm
⑤	1	
⑥	1	 <b>NOT INCLUDED</b> 52S-21780-09
⑦	1	 <b>NOT INCLUDED</b> * OPTION 59C-281C0-00

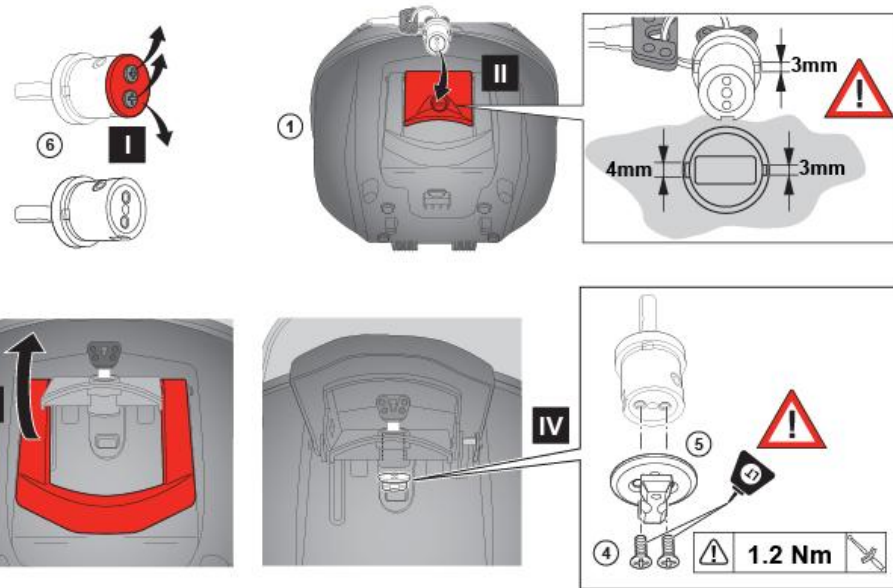

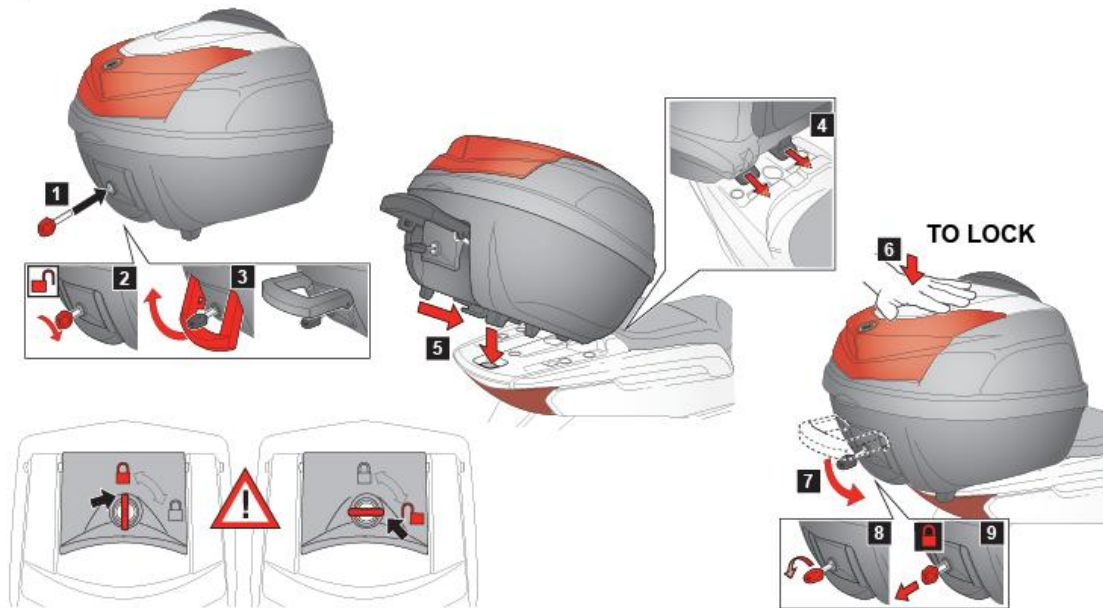

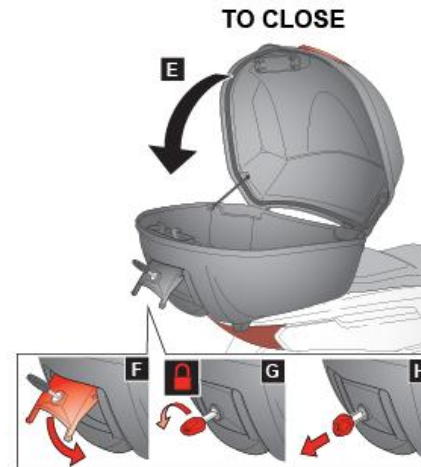
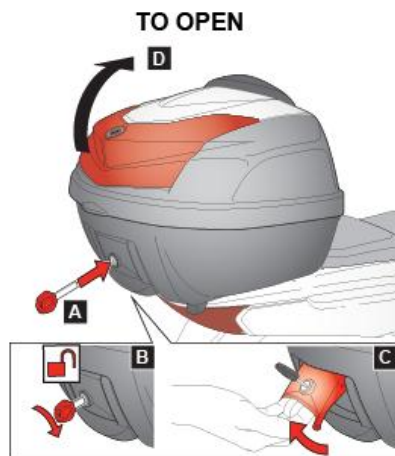



Yamaha Top Case 39L

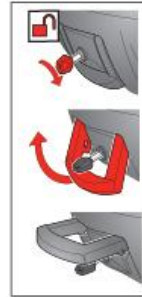
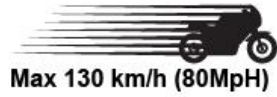

Yamaha Top Case 50L





*Your complimentary  
use period has ended.  
Thank you for using  
PDF Complete.*

[\*Click Here to upgrade to  
Unlimited Pages and Expanded Features\*](#)